

Description

- As Control Circuit of Battery-Backed Memory
- As Measure Against Erroneous Operations at Power On-Off
- As Resetting Function for the CPU-Mounted Equipment --- PC, Printer, VTR, Fax, C-TV etc.
- As Measure Against System Runaway at Instantaneous Break of Power Supply etc.

Features

- Current Consumption is Low ($I_{CC L} = 300 \mu A$ Typ. $I_{CC H} = 30 \mu A$ Typ.)
- Resetting Output Minimum Guarantee Voltage is Low (0.8V Typ.)
- Hysteresis Voltage is Provided (50 mV Typ.)

Ordering Information

Type NO.	Marking	Package Code
S7129SF	729	SOT-23F

Outline Dimensions

unit : mm

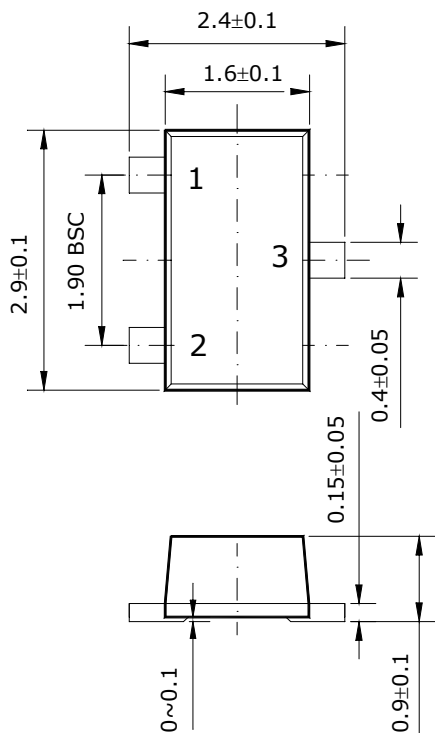

Equivalent Circuit

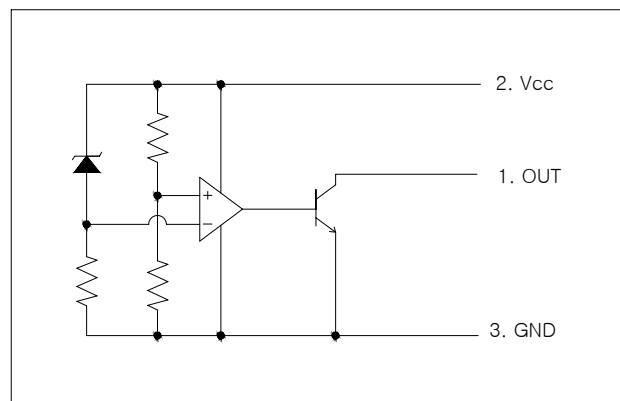

PIN Connections

1. Out
2. Vcc
3. GND

Absolute maximum ratings

(Ta=25°C)

Characteristic	Symbol	Ratings	Unit
Supply voltage	V _{CC}	-0.3 ~ +15	V
Power Dissipation (Package Limitation)	P _D *	300	mW
Operating Temperature	T _{opr}	-30 ~ +75	°C
Storage Temperature	T _{stg}	-55 ~ +150	°C

* With PCB(8×8 mm Copper Area) at Glass Epoxy Board (t=1.7 mm, Area; 20×20 mm)

Electrical Characteristics

(Ta=25°C)

Characteristic	Symbol	Test Circuit	Test Condition	Min.	Typ.	Max.	Unit
Detecting voltage	V _S	1	R _L =200Ω, V _{OL} ≤0.4V	2.75	2.9	3.05	V
Low Level Output voltage	V _{OL}	1	R _L =200Ω	-	-	0.4	V
Output Leakage Current	I _{OH}	1	V _{CC} =15V	-	-	0.1	μA
Hysteresis Voltage	ΔV _S	1	R _L =200Ω	30	50	100	mV
Detecting Voltage Temperature Coefficient	V _S /ΔT	1	R _L =200Ω	-	±0.01	-	%/°C
Circuit current at on Time	I _{CCL}	1	V _{CC} = V _{Smin} - 0.05V	-	300	500	μA
Circuit current at off Time	I _{CCH}	1	V _{CC} =5.25V	-	30	50	μA
Threshold Operating Voltage	V _{opr}	1	R _L =200Ω, V _{OL} ≤0.4V	-	0.8	-	V
'L' Transmission Delay Time	t _{pHL}	2	R _L =1.0 kΩ, C _L =100 pF	-	10	-	μs
'H' Transmission Delay Time	t _{pLH}	2	R _L =1.0 kΩ, C _L =100 pF	-	15	-	μs
Output Current at on Time I	I _{OL I}	1	V _{CC} = V _{Smin} - 0.05V Ta = 25°C	20	-	-	mA
Output Current at on Time II	I _{OL II}	1	V _{CC} = V _{Smin} - 0.05V Ta = -30~+75°C	16	-	-	mA

Test Circuit 1

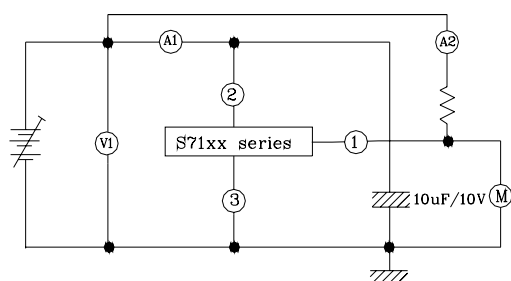

Test Circuit 2

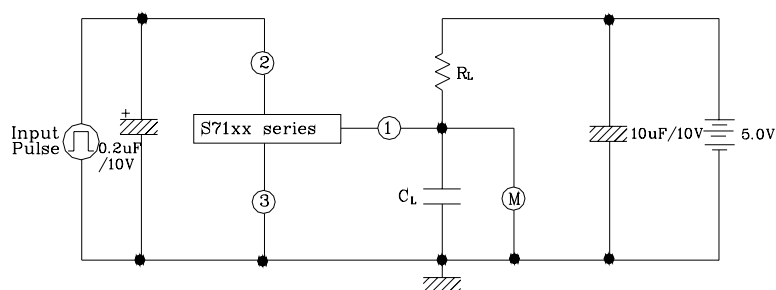

Electrical Characteristic Curves

Fig. 1 $V_{OUT} - V_{CC}$

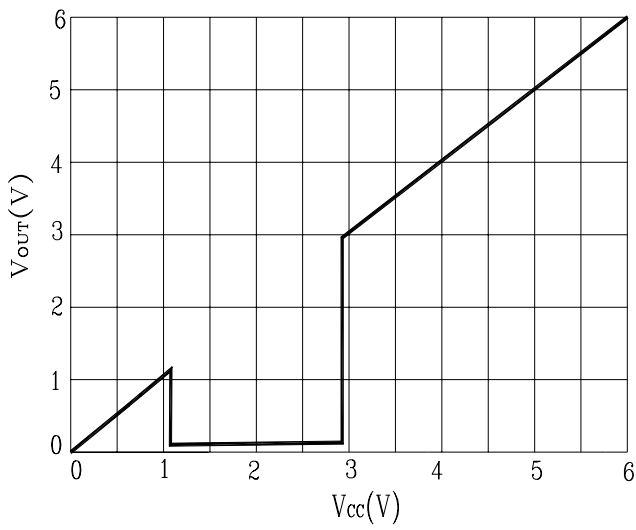

Fig. 2 $I_{CC} - V_{CC}$

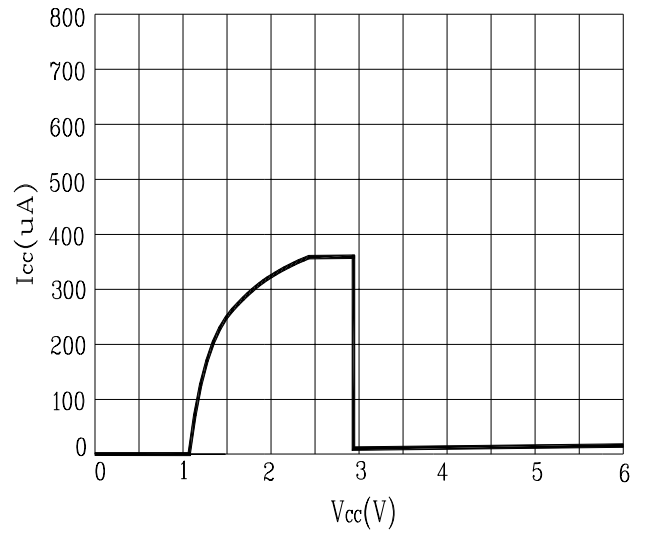

Fig. 3 $I_{CCH} - Temp$

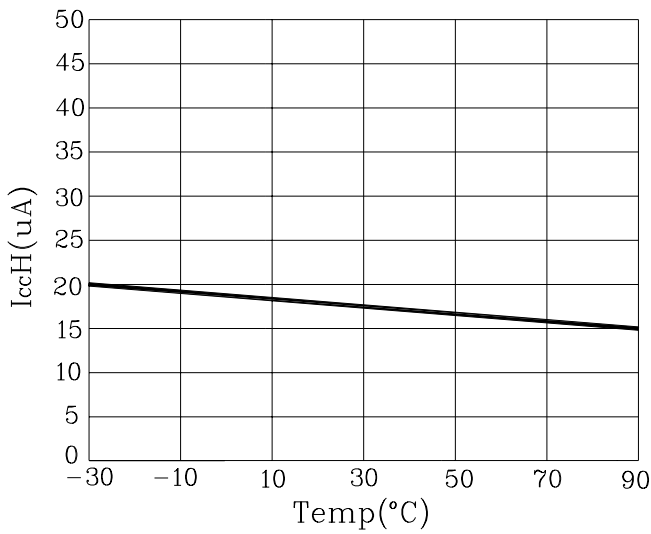

Fig. 4 $I_{OL} - R_L$

